

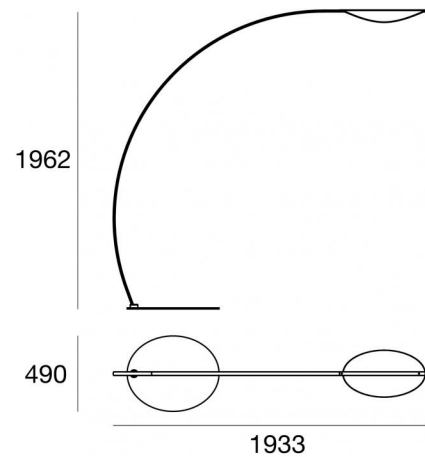

Lampadaire | 220-240 V
200 topLED 25 W DC - 30 W AC | CRI 90
8165

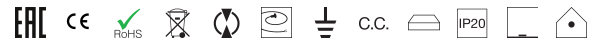

Données techniques	
Année de réalisation	2016
Typologie	Lampadaire
Position d'installation	Sol
Environnement d'installation	Intérieur
Source lumineuse	LED
Pouvoir total	30 W
Flux lumineux (source)	3294 lm
Efficacité nominale	240 - Array AC
Frequency	60 - 50 Hz
Température de couleur / Tone	3000 K
Indice de rendu chromatique	90 Ra
C.C. / V.C.	AC
Classe d'isolation	1
IP	IP20
IP bloc optique	IP40
Essai au fil incandescent	650°
Montage direct sur des surfaces normalement inflammables	Oui
CE	Oui
Driver inclus	Driver
Article à intensité variable	PUSH DIM
Orientable	Non
Basculement	Non
Piétinable	Non
Carrossable	Non
Câble inclus	Oui
Prise électrique	Type F+E
Longueur du câble	2.5 m
Revêtement en résine	Non
Type d'émission lumineuse	Double émission
Poids net	19.040 Kg
Protection contre les décharges électrostatiques	Non
Protection contre les surtensions	Non

Finition corps	
Matériau	Aluminium
Couleur	blanc gaufré RAL 9003
Fabrication	Vernissage
Finition diffuseur	
Matériau	PMMA
Couleur	transparent
Finition monture	
Matériau	métal
Couleur	blanc gaufré RAL 9003
Fabrication	Vernissage



Lampadaire | 220-240 V | 200 topLED 25 W DC - 30 W AC | CRI 90
8165

Double emission floor lamp for indoor application. The warm white LED light source with a general lighting light distribution is composed of 200 topped LEDs with CCT of 3000 K and a CRI 90; the source luminous flux is 3294 lm, with a 131.8 lm/W nominal luminous efficacy.

The device body is made of aluminium and features a embossed white ral 9003 finish, processed by means of coating; the diffuser is made of pmma with a laser engravings treatment; the mounting frame is made of metal, with a embossed white ral 9003 finish, processed by means of coating. The ingress protection degree is IP20; the total weight is of 19.040 kg.

The total absorbed power is 30 W. The power supply cable is included and features a 2.5 m lenght.

The device features protection class I and can be floor-mounted.

Compliant with the EN 60598-1 standard and its specific provisions.

Classe d'efficacité énergétique

Ce produit contient 2 sources lumineuses de classe d'efficacité énergétique E.

Caractéristiques Techniques de l'éclairage

Light Output Ratio (LOR)	75 %
Flux lumineux (source)	3294 lm
Flux lumineux du luminaire	2489 lm
Consumption	30 W
Efficacité lumineuse du luminaire	82 lm/W
Température de couleur	3000 K
Standards de Concordance de Couleur	3 Step MacAdam
Indice de rendu chromatique	90 Ra
Température de jonction (appareil)	80

Température standard de l'environnement de 25°C

LED Life / Failure Ratio

L80 B20 C0 80000h

OPTICAL

Light distribution simmetry	Symmetrical 2 assis
Optique C0/C180	180°

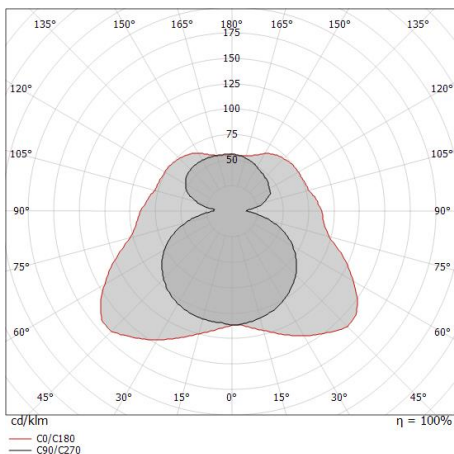

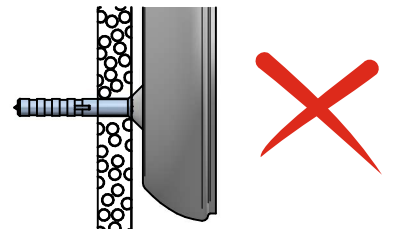
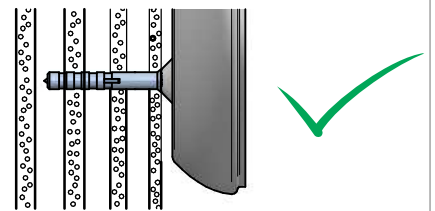
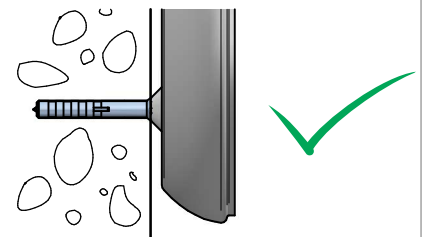
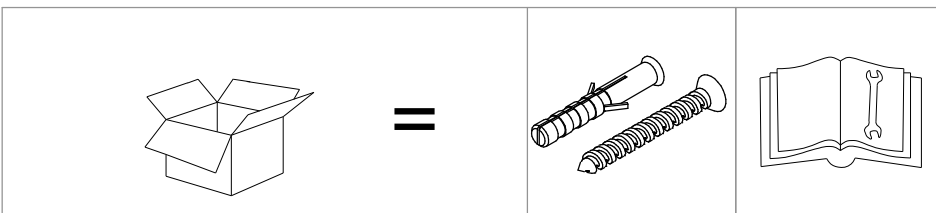
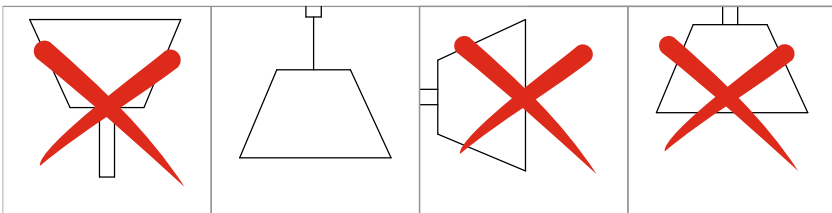
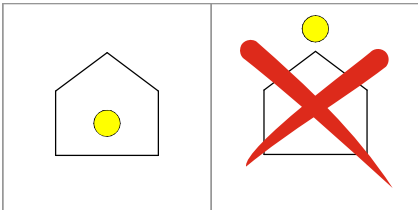
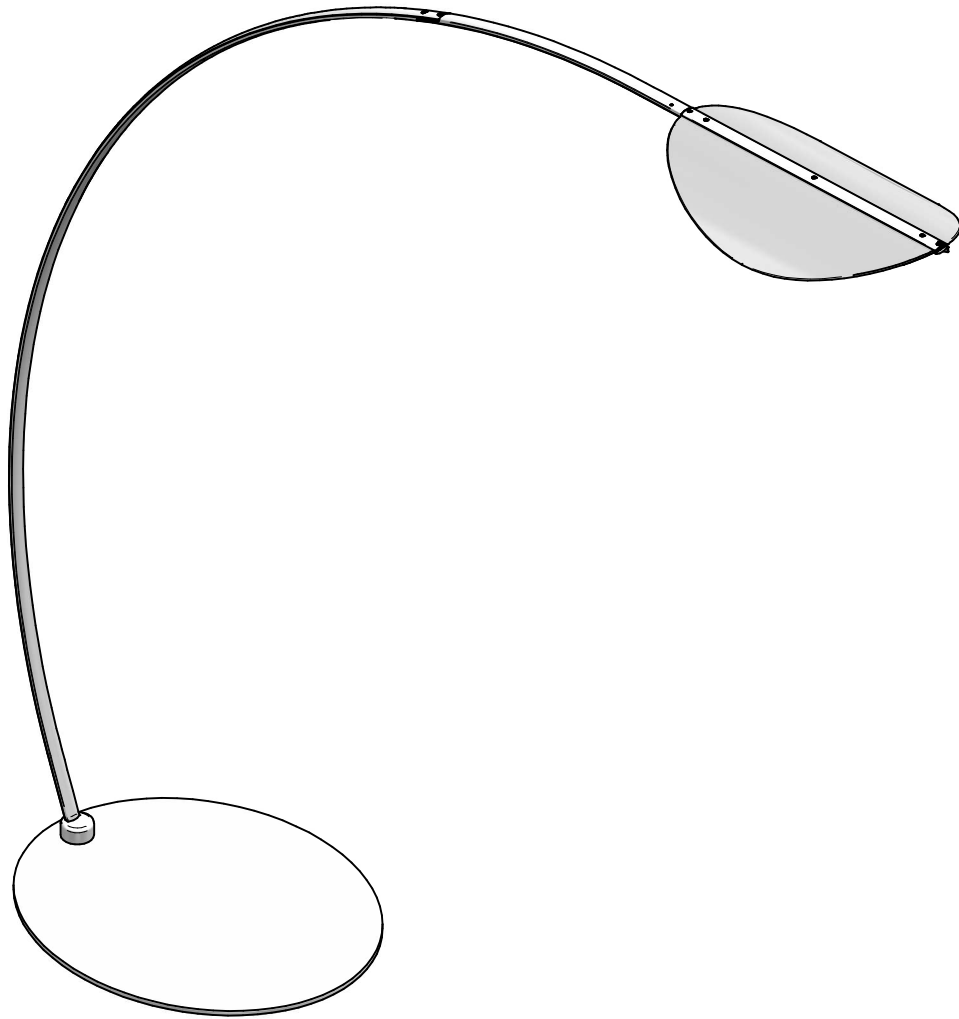

1

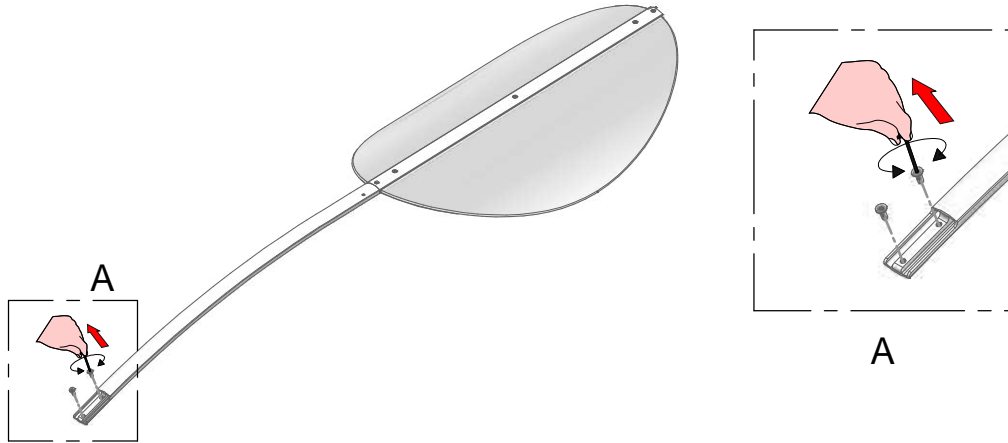

2

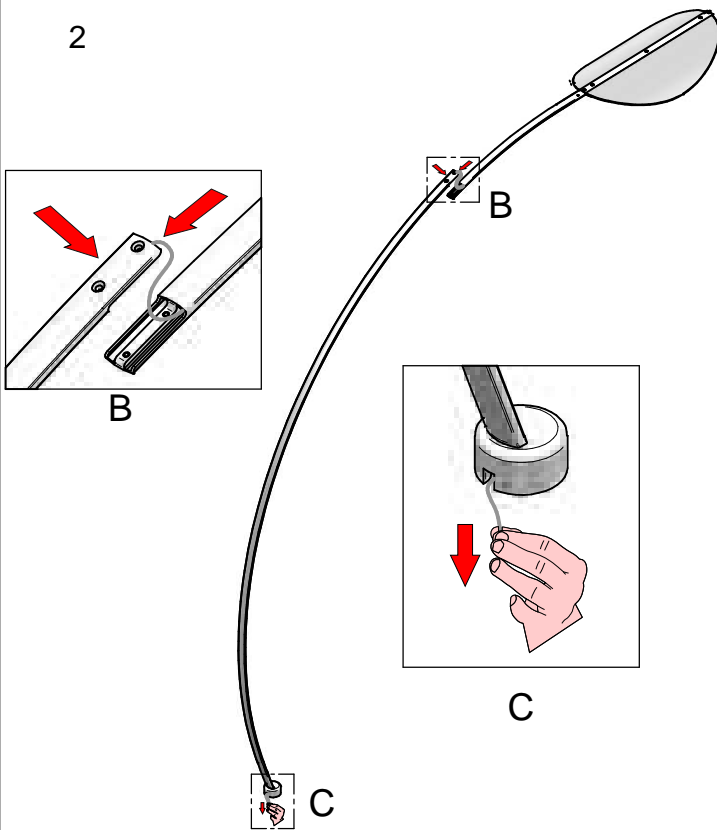

3

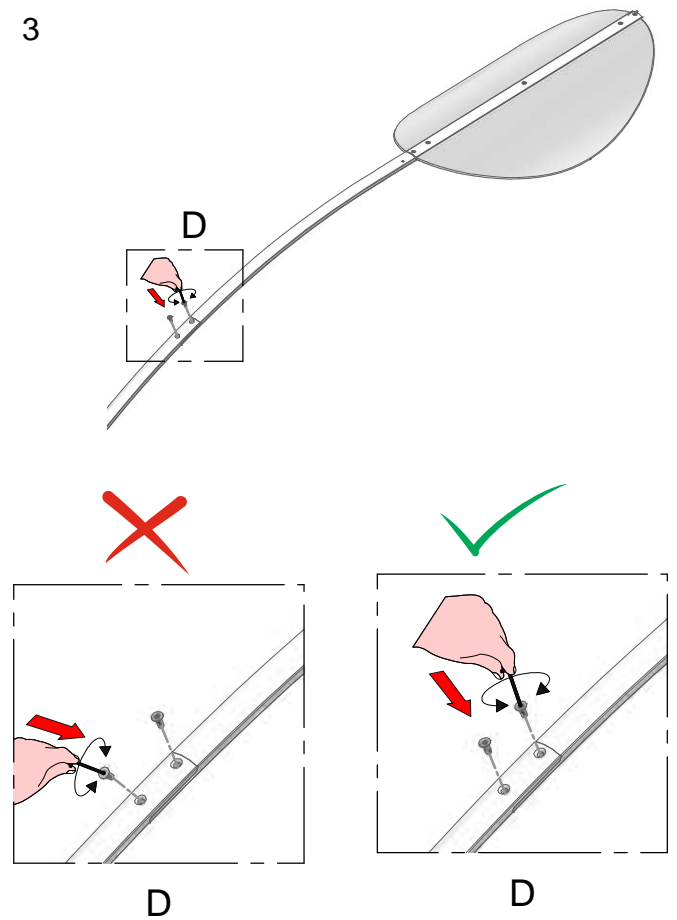

4

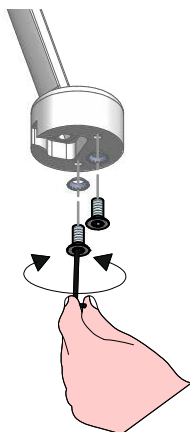

5

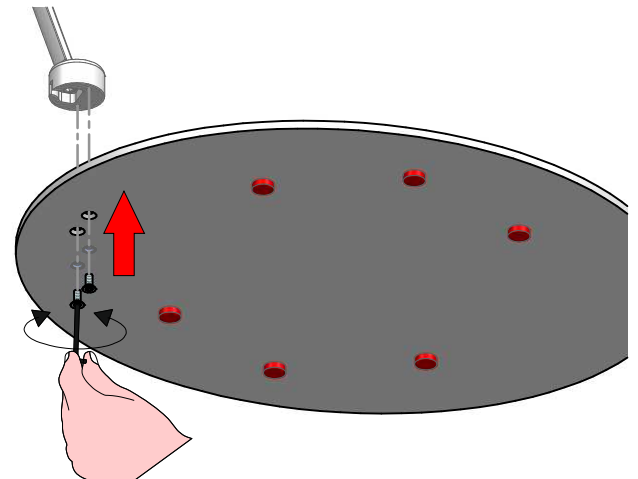

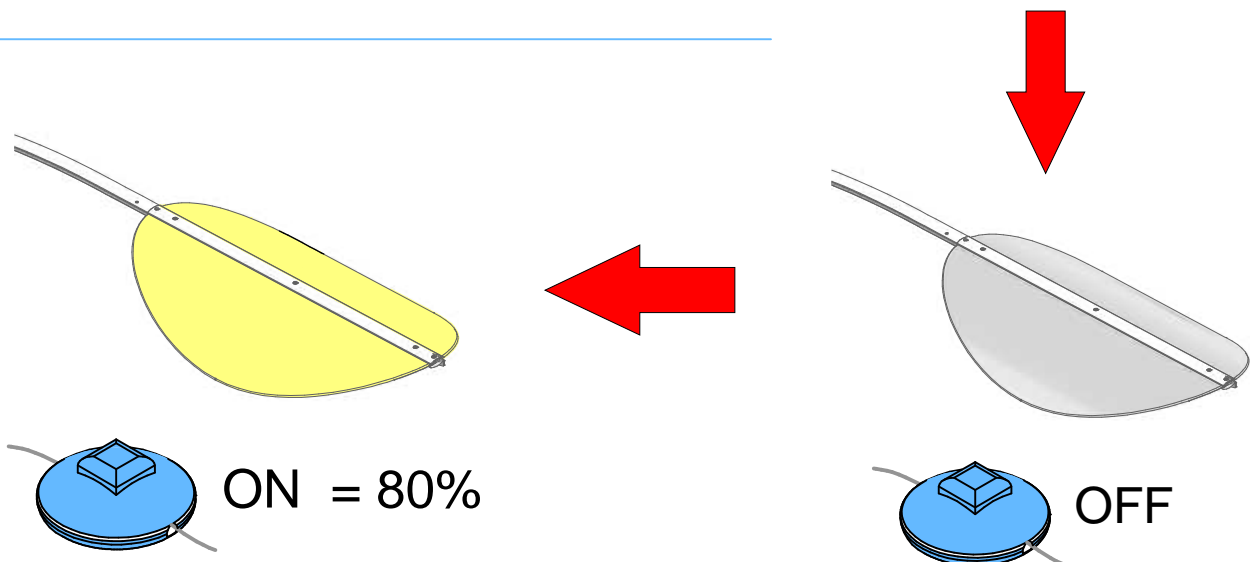
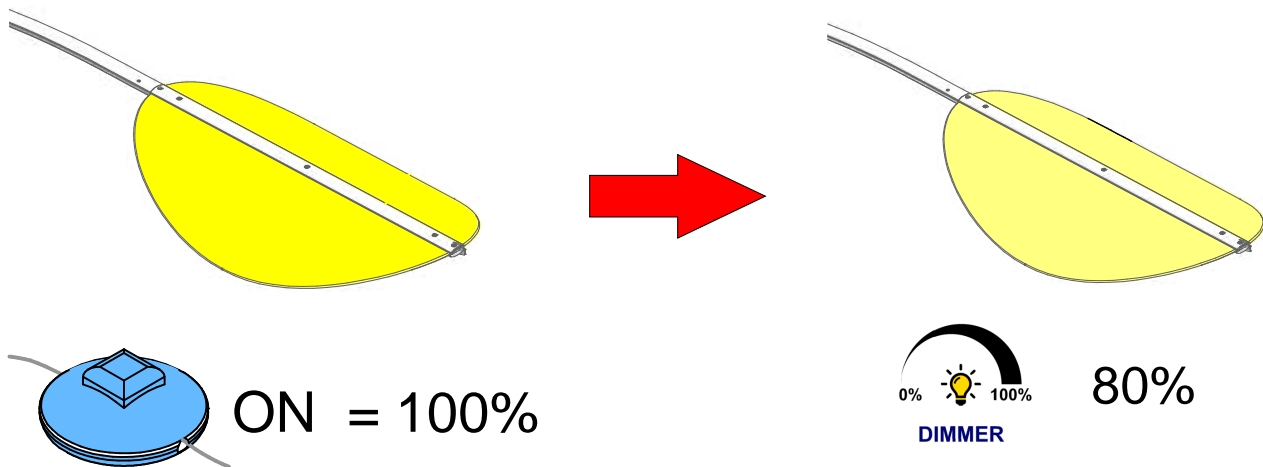
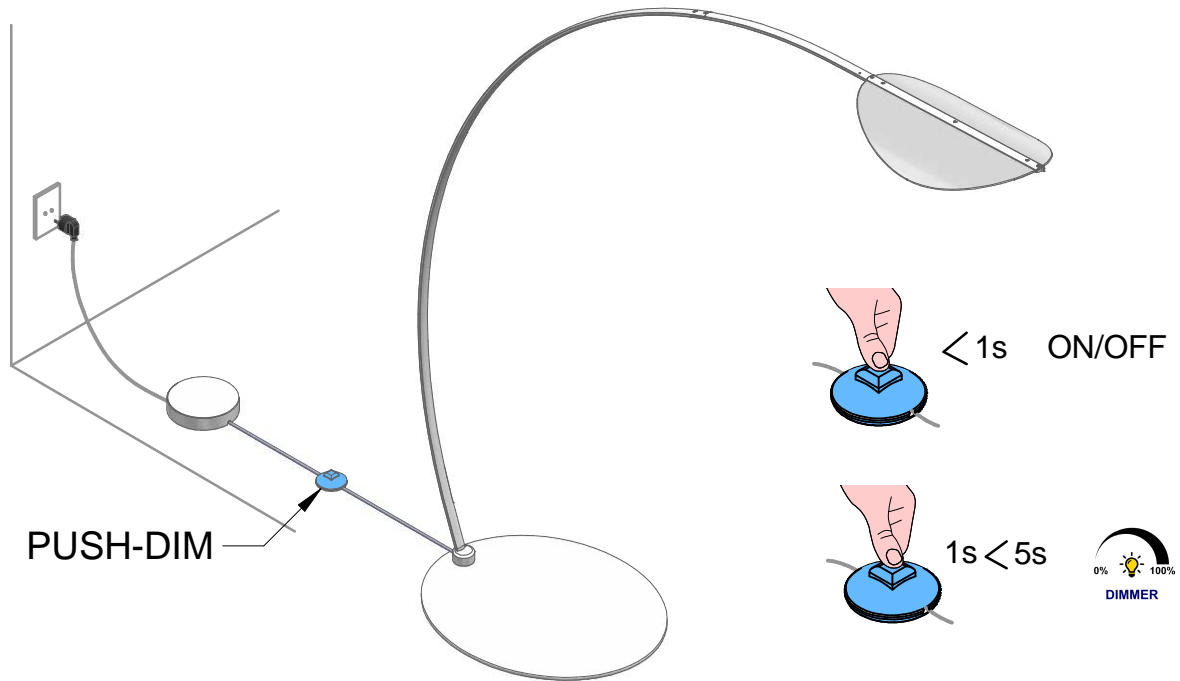

ISTRUZIONI PER IL LAVAGGIO DELL'APPARECCHIO D'ILLUMINAZIONE
LUMINAIRE CARE INSTRUCTIONS
ISTRUCCIONES PARA LIMPIAR LA LUMINARA
INSTRUCTIONS POUR LE LAVAGE DE L'APPAREIL D'ECLAIRAGE
ANLEITUNG ZUR REINIGUNG DES BELEUCHTUNGSGERATS

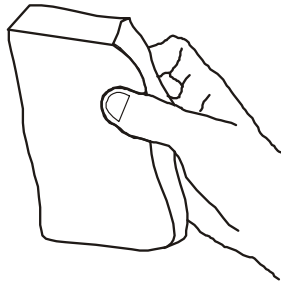
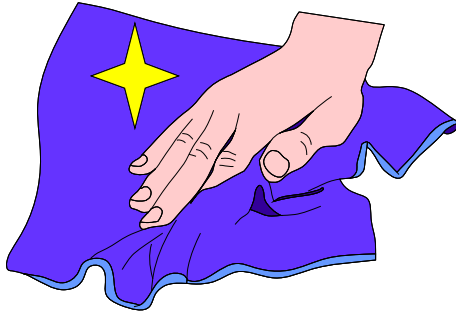

IT - ATTENZIONE!!!

Lavare la superficie del diffusore luce con panno umido, utilizzando solo acqua e sapone neutro.

EN - WARNING!!!

Wipe clean with a cloth dampened in water with neutral detergent.

ES - ATENCION!!!

Limpie la superficie del difusor con un pano humedecido con agua y jabon neutro.

FR - ATTENTION!!!

Laver la surface du diffuseur de lumiere a l'aide d'un chiffon humide et en utilisant seulement de l'eau et du savon neutre.

DE - ACHTUNG!!!

Die oberfläche vom lampenschirm mit einem feuchten lappen reinigen. De lappen mit wasser und neutralseife befeuchten.

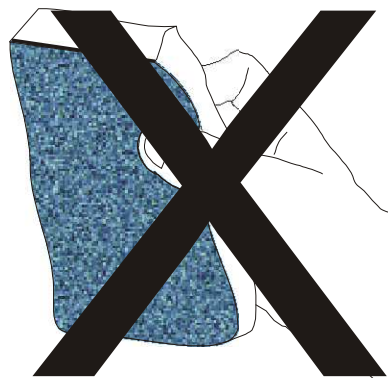

IT - ATTENZIONE!!!

Non utilizzare panni abrasivi e/o solventi.

EN - WARNING!!!

Avoiding the use of chemical solvents and/or abrasive cloths.

ES - ATENCION!!!

No utilizar panos abrasivos y solventes.

FR - ATTENTION!!!

Ne pas utiliser de chiffons abrasifs ou de dissolvants.

DE - ACHTUNG!!!

Abschleifende tuche und/oder losungmittel nicht benutzen.

